

NATIONAL ENTRANCE SCREENING TEST (NEST – 2017)
SET B

Total Marks: 180

Time: 3 hours

General instructions

1. This question booklet contains five sections.
2. Section 1 is the General section and is compulsory. This section carries 30 marks.
3. Sections 2 to 5 are for the subjects Biology, Chemistry, Mathematics and Physics, respectively. Each of these sections carries 50 marks. You should attempt **at least three** of these four subject sections.
4. Read the instructions given at the beginning of each section carefully.
5. **Calculator, cell phone, log table, etc. are NOT permitted in the examination hall.**
6. Answers to the questions are to be marked on the **OMR sheet provided**.
7. **Please make sure that the question booklet code (A or B) matches with the OMR sheet code (A or B).** In case of any discrepancy, inform the invigilator immediately.
8. Return the OMR sheet to the invigilator at the end of the examination.

Instructions for writing on OMR sheet

1. Read and follow the instructions given on the OMR sheet.
2. As far as possible, fill in the answers only after you are sure that you do not need to change them. In case you do have to change the answer after filling, erase the mark completely so that no black spot is left inside the bubble.
3. **Check that you are filling the correct answers for the correct section on the OMR sheet.**
4. **Your examination number (as given in the admit card) MUST BE ENTERED CORRECTLY. If entered incorrectly or not entered at all, the OMR sheet shall be treated as invalid and shall not be assessed.**

Some useful constants

Acceleration due to gravity on Earth	g	10.0 m s^{-2}
Universal gas constant	R	$8.31 \text{ J mol}^{-1} \text{ K}^{-1}$
Atmospheric pressure	1 atmos	10^5 Pa
Permeability of free space	μ_0	$1.26 \times 10^{-6} \text{ Hm}^{-1}$
Speed of light in vacuum	c	$3.00 \times 10^8 \text{ m s}^{-1}$
For monatomic gasses	γ_m	$5/3$
For diatomic gasses	γ_d	$7/5$

SPACE FOR ROUGH WORK

Section 1: GENERAL

Marks for Section 1: 30

This section contains 10 questions.

*For each question, **only one** of the four options is a correct answer. For each question, a correct answer will earn 3 marks. For this **GENERAL** section, a wrong answer or an unattempted question will earn 0 marks.*

1.1 The British scientist credited with experimentally demonstrating Albert Einstein's theory of general relativity was

- (A) Arthur Stanley Eddington. (B) Alan Mathison Turing.
(C) Bertrand Arthur William Russell. (D) Joseph John Thomson.

1.2 My friend saw a movie recently and said, "it was great!" She gave the following reasons to support her claim. The reason that is **NOT** based on facts is:

- (A) It ran house-full for four weeks in a row.
(B) Critics have rated it as the best movie of the year.
(C) The government has exempted it from tax.
(D) No one will ever make a better movie.

1.3 An astronomer, a biologist, a chemist, a dentist, an engineer, a farmer, a geologist and a historian sit at a round table. The astronomer is second to the right of the engineer who is the neighbour of the chemist and the geologist. The dentist is neither a neighbour of the astronomer nor of the farmer. The geologist is the neighbour of the farmer. The biologist is not sitting between the dentist and the historian. The historian is not between the farmer and the dentist. Choose the correct statement.

- (A) The farmer is sitting opposite to the chemist.
(B) The dentist is sitting opposite to the engineer.
(C) The biologist is sitting opposite to the geologist.
(D) The historian is sitting opposite to the astronomer.

1.4 A businessman instituted an annual award in a city school, with a part of the award given to the school itself to improve its facilities. It was stated that if a student from a wealthy family were to top the annual examination, the school would receive twice the amount awarded to the student. On the other hand, if a student from a poor family were to top the annual examination, the student would be awarded twice the amount that the school would receive. In one year, two students, one rich and one poor, jointly topped the annual examination. What fraction of the award money did the school receive in this case?

- (A) $\frac{1}{2}$ (B) $\frac{1}{3}$ (C) $\frac{2}{7}$ (D) $\frac{2}{9}$

1.5 A set of four switches W, X, Y and Z are connected to four lights 1, 2, 3 and 4. Each switch operates in the following way: (i) X toggles (changes from on to off or from off to on) the state of lights 1 and 2 (ii) Y toggles the state of lights 1 and 3 (iii) Z toggles the state of lights 1 and 4 (iv) W toggles the state of lights 2 and 4. All lights were switched off initially. The switches are now flipped in the order YXZW. Choose the correct status of all 4 lights after the operation in the order 1-2-3-4.

- (A) On-Off-On-Off (B) Off-On-On-On
 (C) Off-On-Off-On (D) Off-Off-Off-Off

Analyse the following data table carefully and answer questions 1.6 and 1.7.

Given below is data on the height, coordinates, number of ascents and failed attempts until 2004 for the top 10 tallest mountain peaks in the world. The ascents or failed attempts include only announced expeditions.

Rank	Peaks	Height (metres)	Coordinates	Successful Ascents	Failed Attempts
1	Everest	8848	27°59'17" N 86°55'31" E	145	121
2	K2	8611	35°52'53" N 76°30'48" E	45	44
3	Kangchenjunga	8586	27°42'12" N 88°8'51" E	38	24
4	Lhotse	8516	27°57'42" N 86°55'59" E	26	26
5	Makalu	8485	27°53'23" N 87°5'20" E	45	52
6	Cho Oyu	8188	28°5'39" N 86°39'39" E	79	28
7	Dhaulagiri I	8167	28°41'48" N 83°29'35" E	51	39
8	Manaslu	8163	28°33'0" N 84°33'35" E	49	45
9	Nanga Parbat	8126	35°14'14" N 74°35'21" E	52	67
10	Annapurna I	8091	28°35'44" N 83°49'13" E	36	47

(Source: Wikipedia)

1.6 Based on the data above, choose the correct statement.

- (A) The difficulty in scaling a peak depends on the height.
- (B) The difficulty in scaling a peak increases with the number of attempts.
- (C) Cho Oyu is the easiest peak to scale.
- (D) Makalu is the hardest peak to scale.

1.7 Kangchenjunga is located to the

- (A) South-west of Manaslu.
- (B) North-west of Lhotse.
- (C) North-east of Cho Oyu.
- (D) South-east of Everest.

Read the following passage carefully and answer questions 1.8 to 1.10.

Individuals or species compete for natural resources in a struggle for existence. In such an environment, an individual showing ruthless selfishness as programmed by genes has a higher chance of survival. Blackheaded gulls swallow the young of other Blackheaded gull parents when they are not around, thus saving time and energy for hunting and therefore benefiting from a nutritious meal, without significant effort. On the other hand, individuals in some species also show altruistic behaviour helping other individuals in the group by putting their own lives at risk. Many small birds give 'alarm calls' when hawks are around, which increase their chances of being spotted and hunted by the hawks. Given such a scenario, individuals demonstrating selfish characteristics will eventually populate the colony and most probably destroy the species. However, mutual cooperation between individuals is good for species survival in the long run. Birds can pull out ticks (ectoparasites) from their own feathers; however, they cannot reach the tops of their own heads and need a companion to help them. If a companion bird is helping with this service at the expense of time and energy it expects a similar treatment for itself (cooperation). After removal of ticks from its head, if a bird refuses to reciprocate the service to its companion then it gets all the benefits without paying the cost (cheating / betrayal).

This natural phenomenon is nicely represented in a simple game of 'Iterated Prisoners Dilemma' (iterated because there are repeated encounters) below. When two individuals "M" and "N" only have two cards each to play, they may either 'Cooperate' or 'Betray' without knowing the other's move. The four possible outcomes are shown in the table below. When individuals "M" and "N" both play the 'Cooperate' card, they reap mutual benefit (rewards of 300 points). If both of them play the 'Betray' card, they pay a penalty of 10 points for such mutual betrayal. If individual "M" plays the 'Cooperate' card and individual "N" subsequently betrays, then "M" pays a penalty of 100 points while "N" benefits at the expense of "M" and is rewarded with 500 points (temptation to betray) and vice versa.

	“N” Cooperate	“N” Betray
“M” Cooperate	Both “M” and “N” gain 300 points each.	“M” loses 100 points for cooperating; “N” gains 500 points for betraying.
“M” Betray	“M” gains 500 points for betraying; “N” loses 100 points for cooperating	Both “M” and “N” lose 10 points for mutual betrayal.

1.8 How many points will be awarded to a bird that refuses to reciprocate in the tick removal service in the first round of the ‘Iterated Prisoners Dilemma’ game?

- (A) 300 points (B) 100 points (C) 500 points (D) 10 points

1.9 Based on this passage, choose the correct statement.

- (A) Altruism increases the chance of individual survival.
 (B) Altruism increases the chance of species survival.
 (C) Selfishness is good for species survival.
 (D) Selfishness is bad for individual survival.

1.10 In an example of the removal of ticks in a bird population, the outcome that is **NOT** favourable to the survival of the species is

- (A) all individuals in the bird population always cooperate.
 (B) all individuals in the bird population always betray.
 (C) only a few individuals in the bird population always cooperate.
 (D) only a few individuals in the bird population always betray.

Section 2: Biology

Marks for Section 2: 50

This section contains 15 questions.

*For questions 2.1 to 2.10, **only one** of the 4 options is correct. A correct answer will earn 3 marks, a wrong answer will earn (-1) mark, and an unattempted question will earn 0 marks.*

- 2.1** The mean biomass per unit area and the net primary productivity for four ecosystems P, Q, R and S are tabulated below.

Ecosystem	Mean biomass per unit area (kg m^{-2})	Net primary productivity ($\text{g m}^{-2} \text{yr}^{-1}$)
P	1.6	500
Q	2.0	2000
R	44	2000
S	0.67	71

The four ecosystems most likely could be:

- (A) P: Tropical rainforest Q: Temperate grassland
R: Desert S: Algal bed
- (B) P: Desert Q: Tropical rainforest
R: Temperate grassland S: Algal bed
- (C) P: Algal bed Q: Temperate grassland
R: Tropical rainforest S: Desert
- (D) P: Temperate grassland Q: Algal bed
R: Tropical rainforest S: Desert

- 2.2** Consider two unlinked genes P and Q. A plant with genotype **PPQQ** was crossed with another plant with genotype **ppqq** to obtain F_1 progeny. If the F_1 progeny is test-crossed, the percentage of resultant plants with the genotype **ppqq** will be:

- (A) 50% (B) 25% (C) 100% (D) 10%

- 2.3** Each male gamete of a coconut plant has 16 chromosomes. The number of chromosomes in a cell of the white pulp of coconut is:

- (A) 16 (B) 32 (C) 48 (D) 64

- 2.4** A person is infected with a deadly microorganism. Choose the option that would provide the fastest immune response against the microbe in the affected person.

- (A) Active immunization (B) Passive immunization
(C) Immunization with recombinant DNA (D) Antibiotic administration

2.8 The presence or absence of certain sub-cellular components in the cells of three organisms (P, Q and R) is given below.

Sub-cellular component	P	Q	R
Ribosomes	present	present	present
Microtubules	present	absent	present
Mitochondria	present	absent	present
Lysosomes	present	absent	present
Vacuoles	many small-sized	absent	single large-sized

P, Q and R could most likely be:

- (A) P: frog Q: *E. coli* R: garlic
 (B) P: rat Q: yeast R: onion
 (C) P: *E. coli* Q: *Paramecium* R: mushroom
 (D) P: *Spirogyra* Q: *Bacillus* R: yeast

2.9 A piece of liver tissue is homogenized in a laboratory and the homogenate is subjected to sequential centrifugation at increasing speeds (expressed in $\times g$). Centrifugation is used to separate sub-cellular components based on size and density. The steps carried out in the experiment are shown below.

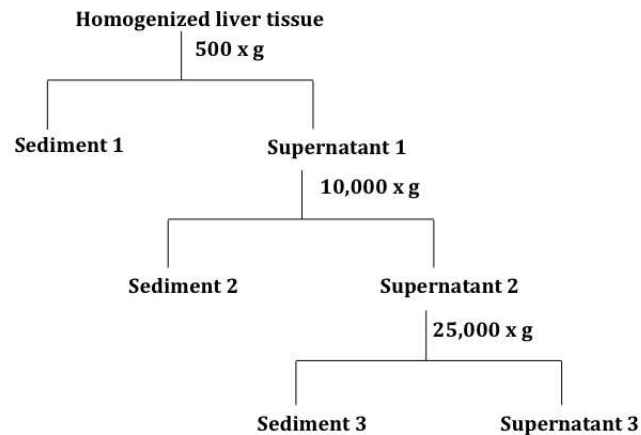

Sediments 1, 2 and 3 would most likely contain:

- (A) 1: Nuclei 2: Ribosomes 3: Mitochondria
 (B) 1: Nuclei 2: Mitochondria 3: Lysosomes
 (C) 1: Lysosomes 2: Mitochondria 3: Nuclei
 (D) 1: Ribosomes 2: Nuclei 3: Mitochondria

2.10 The concentration of dissolved CO₂ in blood varies in different blood vessels. Choose the most appropriate option with decreasing order of dissolved CO₂ concentration in the blood vessels.

- (A) Pulmonary artery > Skin capillaries > Aorta > Alveolar capillaries
- (B) Alveolar capillaries > Aorta > Skin capillaries > Pulmonary artery
- (C) Pulmonary artery > Aorta > Alveolar capillaries > Skin capillaries
- (D) Skin capillaries > Pulmonary artery > Aorta > Alveolar capillaries

For questions 2.11 to 2.15, one or more than one of the 4 options may be correct. Your answer is regarded correct **only if you choose all the correct option(s) and no incorrect option(s)**. A correct answer will earn 4 marks, a wrong answer or an unattempted question will earn 0 marks.

2.11 Two pedigrees (P and Q) are given below. Individual-1 in F₀ generation of pedigree Q is not a carrier of the trait. Circles in the pedigree represent females and squares represent males. Filled shapes indicate affected individuals while unfilled shapes indicate unaffected individuals.

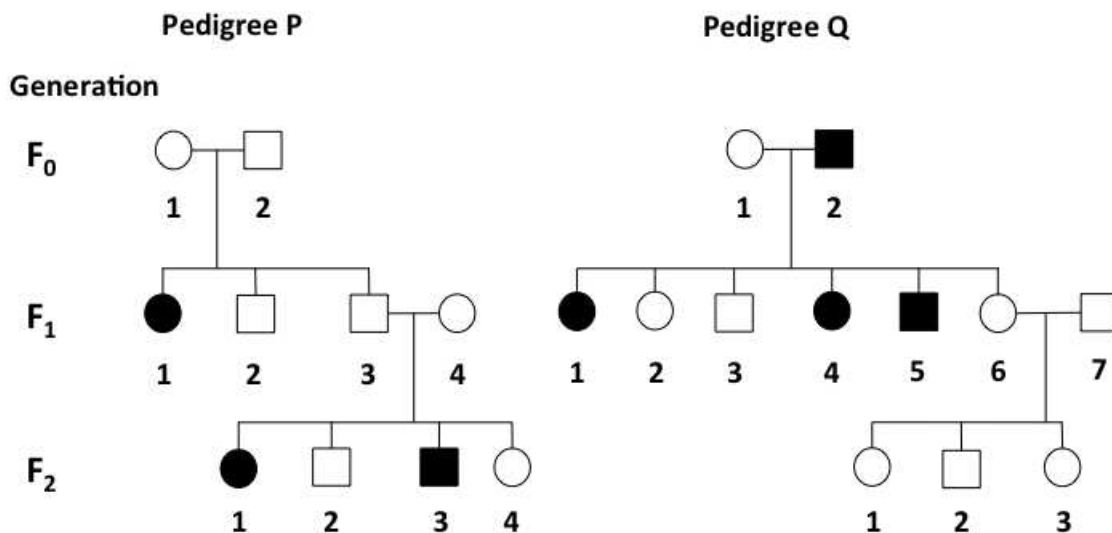

Assuming Mendelian inheritance and complete penetrance of the traits, choose the correct statement(s) from the following:

- (A) Both pedigrees P and Q represent autosomal recessive traits.
- (B) Both pedigrees P and Q represent autosomal dominant traits.
- (C) Pedigree P represents an autosomal recessive trait and Q represents an autosomal dominant trait.
- (D) Pedigree P represents an X-linked recessive trait and Q represents an autosomal recessive trait.

2.12 A student wants to construct a plasmid ‘BacLight’, that when transformed into a bacterium will produce light IF AND ONLY IF the sugar lactose is present in the medium. For this, she uses the following DNA sequences: promoter of repressor (P_i), promoter of *lacZ* (P_z), operator (O) and repressor gene *lacI* from the lactose operon; and a structural gene X, which encodes a protein that produces light. The different DNA elements (II - V) and a vector (I) were digested with restriction enzymes and ligated to produce the plasmid. The DNAs used along with restriction enzyme sites at their ends are given below. Slash (/) in the sequence represents the point at which the restriction enzyme cuts the DNA.

- I : 5' —(G/GATCC) —Vector —(T/CTAGA) —3'
 II : 5' —(T/CTAGA) — P_i —*lacI* —(G/GATCC) —3'
 III : 5' —(T/CTAGA) — P_z —(G/CTAGC) —3'
 IV : 5' —(G/CTAGC) —O —(A/CTAGT) —3'
 V : 5' —(A/CTAGT) —Gene X —(T/CTAGA) —3'

Choose the correct sequence of DNAs that can possibly be ligated to produce the plasmid ‘BacLight’.

- (A) Vector — P_i —*lacI* — P_z —O —Gene X —Vector
 (B) Vector — P_z —O —Gene X — P_i —*lacI* —Vector
 (C) Vector — P_z —Gene X —O — P_i —*lacI* —Vector
 (D) Vector — P_z —O — P_i —*lacI* —Gene X —Vector

2.13 A matrix for the presence or absence of certain features in vertebrates P, Q, R, S and T is given below. Presence of a character is denoted by ‘1’ while absence is denoted by ‘0’.

Vertebrate	Four limbs	4-chambered heart	Amniotic egg	Hair/fur
P	1	0	0	0
Q	1	1	1	1
R	1	0	1	0
S	0	0	1	0
T	1	1	1	0

The statement(s) that hold true is /are:

- (A) Q could either be a rat or a gorilla.
 (B) P most likely represents a bird.
 (C) T could be a lizard.
 (D) S could be a snake.

2.14 The number of double-stranded DNA molecules of an autosome varies at different stages of the meiotic cycle. Choose the correct option(s).

(A)

Meiotic cycle stage	Number of double-stranded DNA
Interphase	2
Metaphase–I	2
Metaphase–II	2
Telophase–II	1

(B)

Meiotic cycle stage	Number of double-stranded DNA
Interphase	2
Metaphase–I	2
Metaphase–II	1
Telophase–II	1

(C)

Meiotic cycle stage	Number of double-stranded DNA
Prophase–II	2
Metaphase–I	2
Metaphase–II	2
Telophase–II	1

(D)

Meiotic cycle stage	Number of double-stranded DNA
Interphase	2
Metaphase–I	4
Metaphase–II	4
Telophase–II	2

2.15 Ecologist David Tilman grew laboratory populations of two species of diatoms namely *Asterionella formosa* (Af) and *Synedra ulna* (Su) in liquid media supplemented with silica. The researcher monitored not only the population growth but also the level of silica in the medium. The results of the experiments are shown in the graphs (P, Q and R) below. P and Q respectively are graphs obtained when Af and Su are grown separately. Graph Q is obtained when Af and Su are grown together.

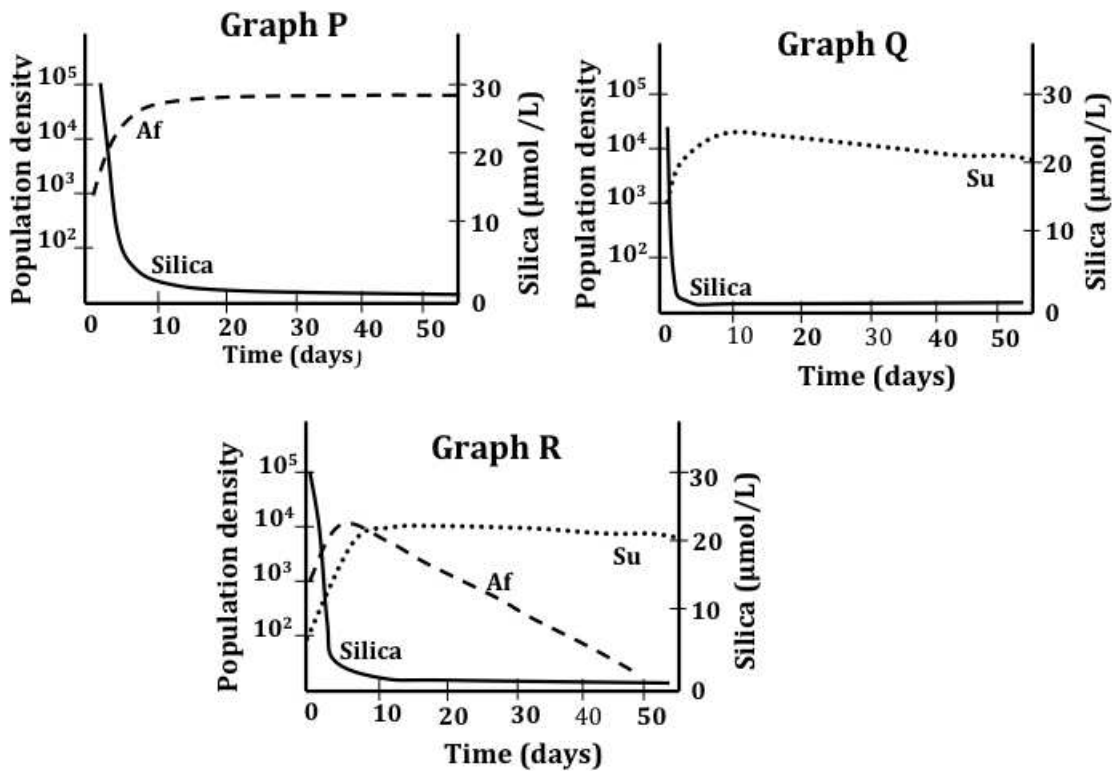

The correct conclusion(s) that can be drawn from the results is/are:

- (A) When grown together, presence of Af in the medium has a positive effect on the growth of Su.
- (B) When grown together, Su reduces silica concentration to a level that does not allow Af to multiply.
- (C) Af reduces resource availability at a faster rate than Su.
- (D) There is competition for the resource between Af and Su.

Section 3: Chemistry

Marks for Section 3: 50

This section contains 15 questions.

*For questions 3.1 to 3.10, **only one** of the 4 options is correct. A correct answer will earn 3 marks, a wrong answer will earn (-1) mark, and an unattempted question will earn 0 marks.*

- 3.1** Consider the two first order reactions $X \rightarrow Y$ and $Y \rightarrow X$ for which the rate constants k_1 and k_2 are $4.0 \times 10^3 \text{ s}^{-1}$ and $2.0 \times 10^3 \text{ s}^{-1}$ respectively. One mole of X and three moles of Y are allowed to react and the concentrations of X and Y are measured as a function of time and plotted.

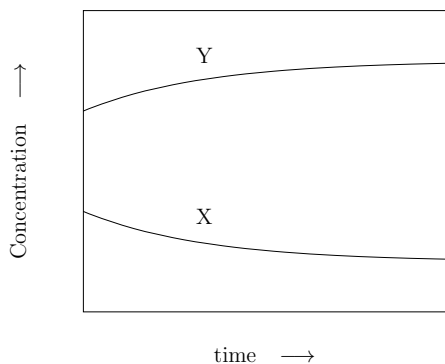

Fig. 1

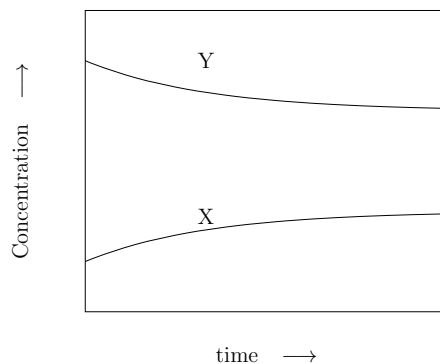

Fig 2

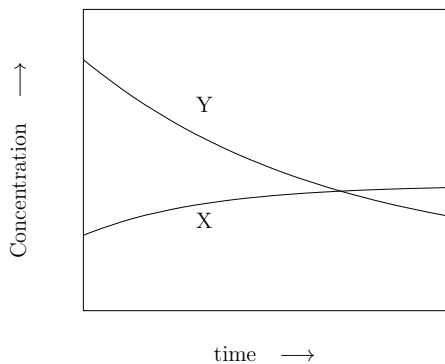

Fig. 3

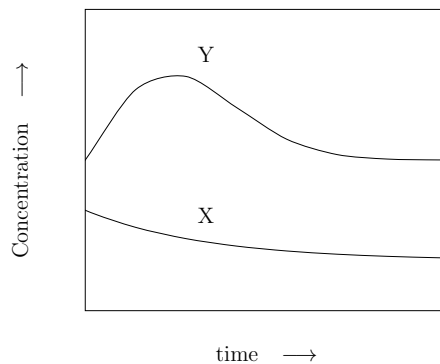

Fig. 4

The correct figure showing the variation of the concentrations $[X]$ and $[Y]$ with time and the correct equilibrium concentrations $[X]_{eq}$ and $[Y]_{eq}$ of X and Y are (Figures are not drawn to scale.)

- | | |
|--|--|
| (A) Fig. 1 and $[X]_{eq} = \frac{4}{3}$, $[Y]_{eq} = \frac{8}{3}$ | (B) Fig. 2 and $[X]_{eq} = \frac{4}{3}$, $[Y]_{eq} = \frac{8}{3}$ |
| (C) Fig. 3 and $[X]_{eq} = \frac{8}{3}$, $[Y]_{eq} = \frac{4}{3}$ | (D) Fig. 4 and $[X]_{eq} = \frac{3}{4}$, $[Y]_{eq} = \frac{3}{2}$ |

3.2 An alkaline earth metal (M) dissolves in liquid ammonia forming a deep blue-black solution. The reaction involved is

- (A) $M + 2 NH_3 \rightarrow M(NH_2)_2 + H_2$
 (B) $M + x NH_3 \rightarrow [M(NH_3)_x]$
 (C) $M + 2 NH_4OH \rightarrow M(OH)_2 + 2 NH_3$
 (D) $M + (x + 2y) NH_3 \rightarrow [M(NH_3)_x]^{2+} + 2[e(NH_3)_y]^-$. (e represents electron)

3.3 The three thermodynamic states P, Q and R of a system are connected by the paths shown in the figure given on the right. The entropy change in the processes $P \rightarrow Q$, $Q \rightarrow R$ and $P \rightarrow R$ along the paths indicated are ΔS_{PQ} , ΔS_{QR} and ΔS_{PR} respectively. If the process $P \rightarrow Q$ is adiabatic and irreversible, while $P \rightarrow R$ is adiabatic and reversible, the correct statement is

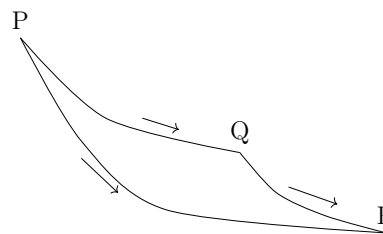

- (A) $\Delta S_{QR} > 0$ (B) $\Delta S_{PR} > 0$ (C) $\Delta S_{QR} < 0$ (D) $\Delta S_{PQ} < 0$

3.4 A mixture of two miscible volatile ideal liquids P and Q (obeying Raoult's law) is kept in a vessel (molar ratio of P and Q in the mixture is m). At a suitable temperature T , the vapour above the liquid is condensed in another vessel. The liquid obtained on condensation is allowed to evaporate and establish equilibrium with its vapour. The vapour is then condensed in another vessel. The process of such evaporation and condensation is repeated for n times. If the ratio of the vapour pressure of pure P to that of pure Q is p , the molar ratio of P and Q in the condensed liquid obtained after n^{th} cycle (for finite $n > 1$) is

- (A) $p^n m$ (B) $p m^n$ (C) $p^{n/2} m^{n/2}$ (D) $p^n m^n$

3.5 The energy of an electron in the $1s$ orbital of H^- , He, Li^+ and Be^{2+} follows the order

- (A) $H^- > He > Li^+ > Be^{2+}$ (B) $Li^+ > Be^{2+} > He > H^-$
 (C) $Be^{2+} > Li^+ > He > H^-$ (D) $H^- > Li^+ > He > Be^{2+}$

3.6 Silica is a network solid with Si-O-Si bonds. In many aluminosilicates, a few Si atoms in the silica structure are replaced by Al atoms. Zeolites, clays, asbestos etc. are examples of aluminosilicates having different structures. The statement which is **NOT** correct is:

- (A) The basic structural unit in silicates is tetrahedral $(SiO_4)^{4-}$.
 (B) Replacement of a Si atom in silica by an Al atom results in negative charge on the Al atom.
 (C) Silica dissolves in aqueous NaOH to form sodium silicate in which Na^+ is bonded to oxyanions.
 (D) Silicones are examples of silicates.

3.7 Compounds X and Y were isolated from two odoriferous plants. Their structures are shown below.

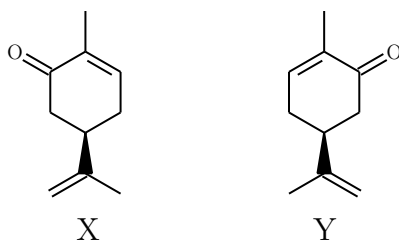

The correct statement with respect to X and Y is:

- (A) X and Y have different melting and boiling points.
- (B) If the double bond and the carbonyl group in the ring of both X and Y are reduced completely, a pair of enantiomers is formed.
- (C) A mixture of equal amounts of X and Y shows optical activity.
- (D) If the carbonyl group in X is reduced to CH_2 group, the product is optically active.

3.8 Nickel metal is purified by vapour phase refining process. This process is based on the fact that

- (A) nickel metal sublimes at high temperature.
- (B) nickel reacts with carbon monoxide to form nickel carbonyl which decomposes at high temperature to form nickel.
- (C) nickel reacts with chlorine to form nickel chloride which is volatile and decomposes easily to nickel.
- (D) nickel can be vapourized under vacuum leaving behind impurities.

3.9 Resonance structures of aniline are shown below

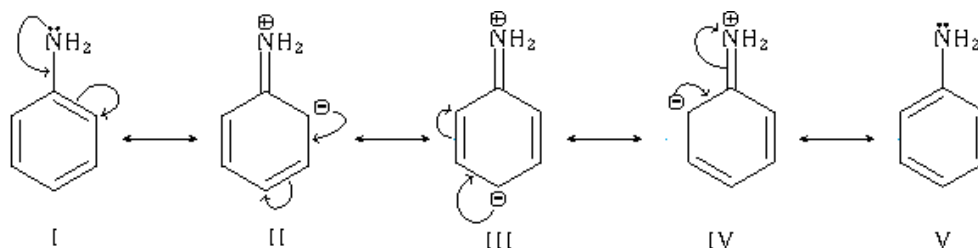

Considering the above structures, it can be concluded that

- (A) 60 % of the molecules of aniline exist as structures II, III and IV.
- (B) In aniline, the N-atom carries one unit positive charge.
- (C) Aniline has dipole moment with the N-atom as the positive end.
- (D) The meta position of aniline is electron deficient in comparison to benzene.

3.10 The reaction of an acid chloride with an aromatic compound in the presence of a Lewis acid to give an acylated aromatic compound is called Friedel-Crafts acylation reaction. It proceeds through a carbocation. The stability of the carbocation is important in determining the product. A carbocation may decompose or rearrange favourably to form another stable carbocation. The major product (X) of the following reaction is

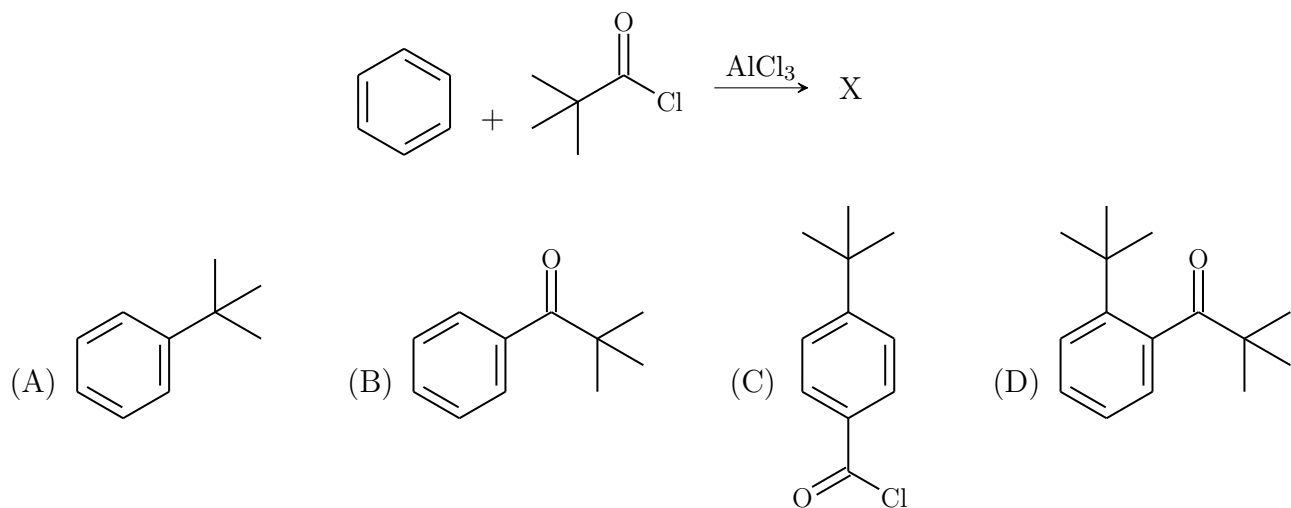

For questions 3.11 to 3.15, one or more than one of the 4 options may be correct. Your answer is regarded correct **only if you choose all the correct option(s) and no incorrect option(s)**. A correct answer will earn 4 marks, a wrong answer or an unattempted question will earn 0 marks.

3.11 The structure of a disaccharide M (molecular mass 342) is given below. Hydrolysis of the disaccharide gives two monosaccharides X and Y. Acetylation using acetic anhydride is one of the methods used in structure determination of carbohydrates. On the basis of the structure of M given below, select the correct option(s).

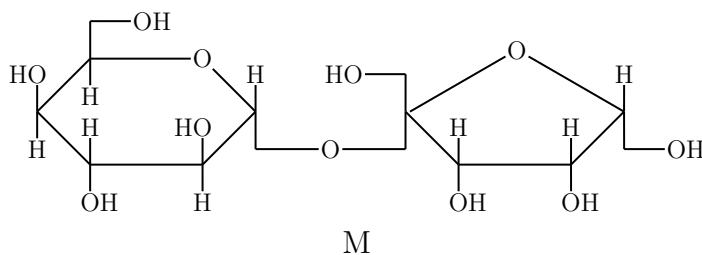

- (A) M is a non-reducing sugar.
- (B) On hydrolysis, M gives one aldohexose and one aldopentose.
- (C) If the specific rotation (α) of X, Y and M are $+52^\circ$, -74° and $+29^\circ$ respectively, the mixture of X and Y, obtained upon hydrolysis of M is laevorotatory.
- (D) 0.171 g of M requires 0.153 g of acetic anhydride for complete acetylation.

3.12 Consider the equilibrium $\text{NH}_4\text{Cl} (\text{s}) \rightleftharpoons \text{NH}_3 (\text{g}) + \text{HCl} (\text{g})$. An inert gas is added to the system at constant volume and temperature. The correct statement(s) is/are:

- (A) The partial pressures of NH_3 and HCl in the system will increase.
- (B) The partial pressures of NH_3 and HCl in the system will remain the same.
- (C) The partial pressures of NH_3 and HCl in the system will decrease.
- (D) The entropy of the system will increase.

3.13 A weak acid H_3A has the three consecutive dissociation constants K_1 , K_2 and K_3 in water as 1.0×10^{-4} , 1.0×10^{-8} and 1.0×10^{-16} respectively at room temperature. A metal M forms salt MA which is sparingly soluble (solubility product $\sim 10^{-30}$) in water. It also forms a water soluble chloride MCl_3 which dissociates into M^{3+} and Cl^- ions completely in aqueous solution. For an aqueous solution of the acid H_3A of concentration C ($\sim 1 \text{ M}$) at room temperature, the correct statement(s) is/are:

- (A) The acid acts as a dibasic acid.
- (B) The H^+ ion concentration in the solution is close to $(K_1 C)^{1/2}$.
- (C) The H^+ ion concentration in the solution is $(3K_1 K_2 K_3 C)^{1/4}$.
- (D) On addition of excess of the soluble salt MCl_3 to the acid solution, the H^+ ion concentration in the solution will be $3C$.

3.14 The six structures (I-VI) of molecules where X , Y , Z are atoms of different elements with different electronegativities, are shown below. The molecules are regular tetrahedral species. Assume the bond lengths in all the structures to be the same.

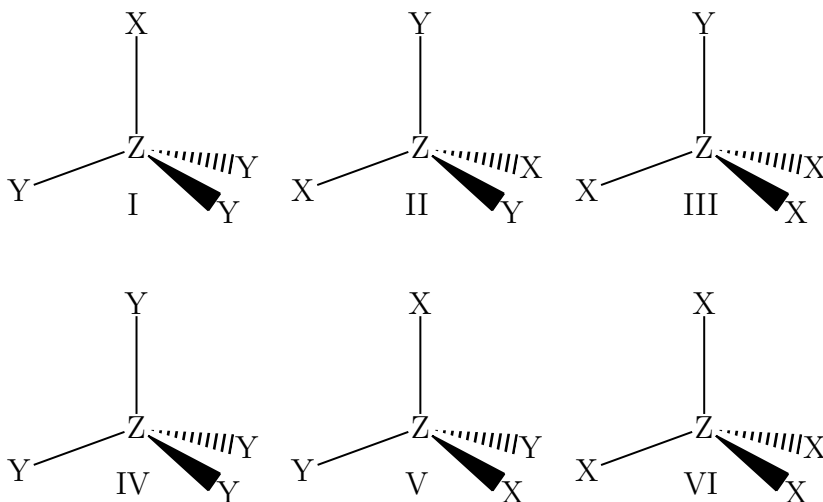

Identify the pair(s) of structures of molecules in which both the members have the same magnitude of dipole moment.

- (A) I and III.
- (B) II and V.
- (C) IV and VI.
- (D) I and V.

3.15 A mixture contains 4-methylaniline, 2-naphthol, 3-chlorobenzoic acid and 1,3-dinitrobenzene. The following scheme of separation is used to separate its constituents.

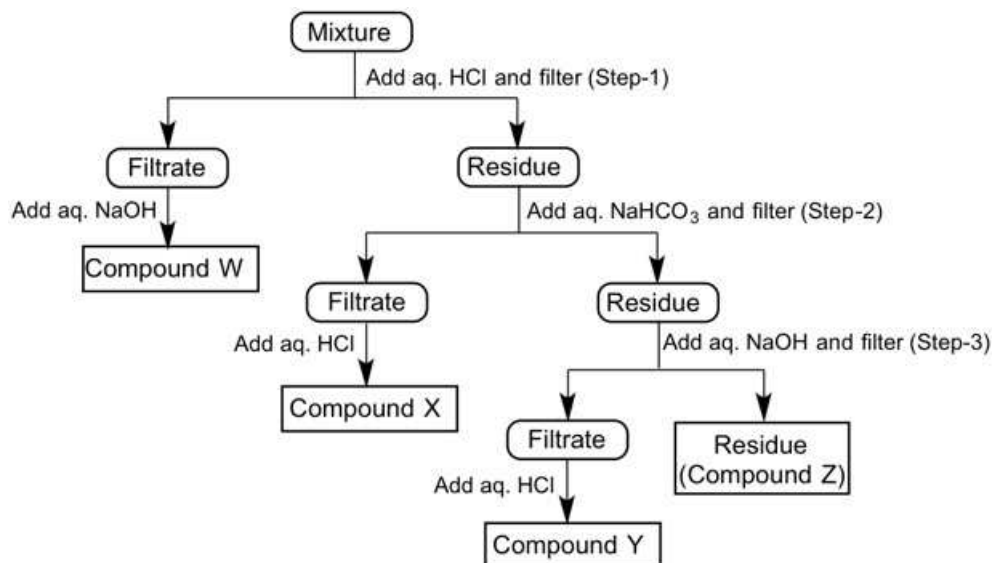

The correct statement(s) regarding the separation method is/are:

- (A) The reagents in Step 2 and Step 3 can be interchanged (i.e. aq. NaOH in Step 2 and aq. NaHCO₃ in Step 3).
- (B) Y is 3-chlorobenzoic acid.
- (C) W and Z are 4-methylaniline and 1,3-dinitrobenzene respectively.
- (D) If the original mixture also contains 4-aminobenzoic acid, it will be present in the filtrate of Step 1.

Section 4: Mathematics

Marks for Section 4: 50

This section contains 15 questions.

*For questions 4.1 to 4.10, **only one** of the 4 options is correct. A correct answer will earn 3 marks, a wrong answer will earn (-1) mark, and an unattempted question will earn 0 marks.*

Notation: Let \mathbb{R} denote the set of all real numbers.

4.1 An examination consists of 10 multiple choice questions, where each question has 4 options, only one of which is correct. In every question, a candidate earns 3 marks for choosing the correct option, and -1 for choosing a wrong option. Assume a candidate answers **all** questions by choosing exactly one option for each. Then the number of distinct combinations of answers which can earn the candidate a score from the set $\{15, 16, 17, 18, 19, 20\}$ is

- (A) 27 (B) 120 (C) 3240 (D) 6480

4.2 If a, b, c are positive real numbers in geometric progression, then the graph of $y = ax^2 + bx + c$ is a curve that

- (A) intersects the x -axis at two points. (B) is entirely below the x -axis.
(C) is entirely above the x -axis. (D) is tangent to the x -axis.

4.3 Let \mathbb{C} be the set of all complex numbers. Let $P = \{z \in \mathbb{C} : |z| = 1\}$ and $Q = \{z \in \mathbb{C} : z^2 = 1\}$. Then

- (A) $P = Q$. (B) P is a proper subset of Q .
(C) $P \cap Q$ is the empty set. (D) Q is a proper subset of P .

4.4 Let the function $f : \mathbb{R} \rightarrow \mathbb{R}$ be defined as

$$f(x) = [\sin x]$$

where for any real number t , $[t]$ denotes the greatest integer not exceeding t . Then f is continuous at

- (A) $\frac{\pi}{2}$ (B) π (C) $\frac{3\pi}{2}$ (D) 2π

4.5 If for some positive integer $n > 1$, we have $1 + x + x^2 + \dots + x^{n-1} = 0$, then $\sum_{k=0}^n \left(x^k + \frac{1}{x^k}\right)$

is

- (A) -2 (B) -1 (C) 1 (D) 2

4.6 A cylindrical tank of height 3 units and diameter 2 units, resting on its base, is partially filled with water up to a height h units. Thereafter it is turned horizontal and placed on a level ground with its lateral surface in contact with the ground. In this position, the maximum depth of water is $\frac{1}{2}$ units. Then h is

- (A) $1 - \frac{3\sqrt{3}}{4\pi}$ (B) $1 - \frac{3}{4\pi}$ (C) $1 - \frac{3\sqrt{3}}{2\pi}$ (D) $1 - \frac{3}{2\pi}$

4.7 If a, b, c are the roots of $x^3 + px + q = 0$, then the determinant

$$\begin{vmatrix} 1+a & 1 & 1 \\ 1 & 1+b & 1 \\ 1 & 1 & 1+c \end{vmatrix}$$

is equal to

- (A) $p+q$ (B) $p-q$ (C) pq (D) $2p+q$

4.8 Let $f : \mathbb{R} \rightarrow \mathbb{R}$ be an odd function and suppose $f(e^x) = e^{f(x)}$ for all $x \in \mathbb{R}$. Then

- (A) $f(1/e) < f(1) < f(e)$ (B) $f(1/e) > f(1) > f(e)$
 (C) $f(1) < f(1/e) < f(e)$ (D) $f(1) > f(1/e) > f(e)$

4.9 The value of the integral $\int_{\pi}^{2\pi} \frac{(x^2 + 2) \cos x}{x^3} dx$ is

- (A) $-\left(\frac{5}{4\pi^2}\right)$ (B) $-\left(\frac{1}{4\pi^2}\right)$ (C) $\frac{1}{4\pi^2}$ (D) $\frac{5}{4\pi^2}$

4.10 Let $X = \{x \in \mathbb{R} | x \neq -3\}$. Let $f : X \rightarrow \mathbb{R}$ be a function defined as

$$f(x) = \begin{cases} \frac{x^3 - 27}{x^2 - 9} & \text{if } x \neq 3 \\ \frac{9}{2} & \text{if } x = 3 \end{cases}$$

Then f is

- (A) continuous at all real numbers.
 (B) continuous at all points in the domain.
 (C) discontinuous at only $x = -3$.
 (D) discontinuous at only $x = 3$.

For questions 4.11 to 4.15, **one or more than one** of the 4 options may be correct. Your answer is regarded correct **only if you choose all the correct option(s) and no incorrect option(s)**. A correct answer will earn 4 marks, a wrong answer or an unattempted question will earn 0 marks.

4.11 Let $\hat{i}, \hat{j}, \hat{k}$ be three mutually orthogonal unit vectors and let x, y, z be three distinct real numbers. If the vectors $\vec{u} = x\hat{i} + y\hat{j} + z\hat{k}$, $\vec{v} = y\hat{i} + z\hat{j} + x\hat{k}$ and $\vec{w} = z\hat{i} + x\hat{j} + y\hat{k}$ are coplanar then

- (A) $\vec{u} + \vec{v} + \vec{w} = \vec{0}$, where $\vec{0}$ is the null vector.
- (B) $\hat{i} + \hat{j} + \hat{k}$ is normal to the plane containing \vec{u} , \vec{v} and \vec{w} .
- (C) the angle between any two of the vectors \vec{u} , \vec{v} and \vec{w} is 120° .
- (D) $\vec{u} \times \vec{v} = \vec{v} \times \vec{w} = \vec{w} \times \vec{u}$.

4.12 Let $f : X \rightarrow Y$ and $g : Y \rightarrow X$ be two functions such that $(g \circ f)(x) = x$ for all $x \in X$. Then

- (A) f is always onto.
- (B) f is always one-one.
- (C) g is always onto.
- (D) g is always one-one.

4.13 Let P and Q be two 2×2 matrices. Then the identity $(P + Q)(P - Q) = P^2 - Q^2$ is

- (A) true if $\det(P) = \det(Q)$.
- (B) true if P or Q is the identity matrix.
- (C) true if P or Q is the zero matrix.
- (D) true if $PQ = QP$.

4.14 Let $n \geq 1$ be a positive integer. Suppose, between two distinct positive real numbers k and l , n arithmetic means a_1, a_2, \dots, a_n and n harmonic means h_1, h_2, \dots, h_n are inserted. For $i = 1, 2, \dots, n$ and $j = 1, 2, \dots, n$, let $p(i, j) = a_i h_j$ then

- (A) $p(i, j) = kl$ for some i and j .
- (B) if n is even, there are an even number of ordered pairs (i, j) , such that $p(i, j) = kl$.
- (C) if n is odd, there are an even number of ordered pairs (i, j) , such that $p(i, j) = kl$.
- (D) whenever n is odd there is an i such that $p(i, i) = kl$.

4.15 Let Ω be an ellipse and let F_1 and F_2 be its two foci. Let P be a point on the circumference of the ellipse that is neither on the major axis nor on the minor axis. Let PF_1 intersect Ω again at $Q(\neq P)$ and let PF_2 intersect Ω again at $R(\neq P)$. Then

- (A) the perimeters of the triangles PF_1R and PF_2Q are equal.
- (B) the area of the triangles PF_1R and PF_2Q are equal if and only if F_1F_2 is parallel to QR .
- (C) the perimeters of the triangles PF_1R and PF_2Q are bisected by F_1F_2 .
- (D) the two lines F_1F_2 and QR are always parallel.

Section 5: Physics

Marks for Section 5: 50

This section contains 15 questions.

For questions 5.1 to 5.10, **only one** of the 4 options is correct. A correct answer will earn 3 marks, a wrong answer will earn (-1) mark, and an unattempted question will earn 0 marks.

- 5.1** A thin rod of mass 0.3 kg and length 0.2 m is suspended horizontally by a metal wire which passes through its centre of mass and is perpendicular to its length. The rod is set to torsional oscillation with a period of 2 s. The thin rod is replaced by an equilateral triangular lamina which is suspended horizontally from its centre of mass. If its period of oscillations is found to be 10 s, the moment of inertia of the triangular lamina about the axis of suspension is approximately

(A) $5.0 \times 10^{-3} \text{ kgm}^2$ (B) $0.5 \times 10^{-3} \text{ kgm}^2$
(C) $0.5 \times 10^{-4} \text{ kgm}^2$ (D) $2.5 \times 10^{-2} \text{ kgm}^2$

- 5.2** In order to measure physical quantities in the sub-atomic world, the quantum theory often employs energy $[E]$, angular momentum $[J]$ and velocity $[c]$ as fundamental dimensions instead of the usual mass, length and time. Then, the dimension of pressure in this theory is

(A) $\frac{[E]^4}{[J]^3[c]^3}$ (B) $\frac{[E]^2}{[J][c]}$ (C) $\frac{[E]}{[J]^2[c]^2}$ (D) $\frac{[E]^3}{[J]^2[c]^2}$

- 5.3** Three rivers R_1 , R_2 and R_3 merge together to form a river, R_4 . The cross sectional areas of the three rivers R_1 , R_2 and R_3 are in the ratio 1 : 2 : 3 and speed of water flowing in these are in the ratio $1 : \frac{1}{2} : \frac{1}{3}$. Assuming streamline flow, if R_4 has cross sectional area equal to that of R_1 , the ratio of speed of water in R_4 to that in R_1 is

(A) 4 : 1 (B) 3 : 1 (C) 2 : 1 (D) 1 : 1

- 5.4** A solid cylinder of mass m , length l and radius R , is placed on two horizontal parallel rails of separation l . The cylinder carries a constant current i . A uniform magnetic field \vec{B} , directed vertically upwards, is switched on. After travelling a distance a , its speed is (assume rolling without slipping)

(A) $\sqrt{\frac{2ilaB}{3m}}$ (B) $\sqrt{\frac{4ilaB}{3m}}$ (C) $\sqrt{\frac{2ilaB}{m}}$ (D) $\sqrt{\frac{4ilaB}{m}}$

- 5.5** The wavelengths of the K_α X-ray radiations from two sources P and Q are 1.50 \AA and 0.75 \AA ($1 \text{ \AA} = 10^{-10} \text{ m}$). Then most likely,

(A) $P = {}_{41}\text{Nb}$; $Q = {}_{29}\text{Cu}$ (B) $P = {}_{29}\text{Cu}$; $Q = {}_{47}\text{Ag}$
(C) $P = {}_{29}\text{Cu}$; $Q = {}_{41}\text{Nb}$ (D) $P = {}_{41}\text{Nb}$; $Q = {}_{27}\text{Co}$

5.6 A circuit with Si and Ge diodes is shown in the accompanying figure. The barrier potential for Silicon is $V_{Si}=0.7\text{ V}$ and that of Germanium is $V_{Ge}=0.3\text{ V}$. If the input voltage is 20 V , then the voltage V_A measured across the resistance $R_L = 1\text{ k}\Omega$ is

- (A) 19.7 V (B) 19.3 V
 (C) 19.0 V (D) 18.7 V

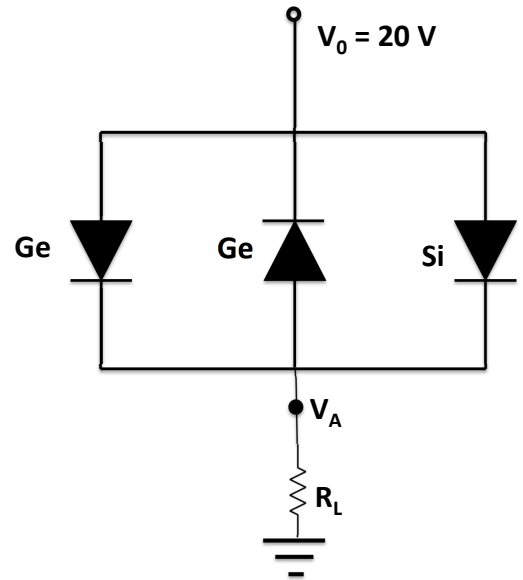

5.7 The intensity of the central maximum in Young's double-slit experiment is $4I$. The intensity at the first minimum is zero and the distance between two consecutive maxima is w . The distance from the central maximum to the position where the intensity falls to I is

- (A) $\frac{2}{3}w$ (B) $\frac{1}{4}w$ (C) $\frac{1}{2}w$ (D) $\frac{1}{3}w$

5.8 A mixture of polarised and unpolarised light is incident on a polariser. As the polariser is rotated through 360° , it is found that the minimum and the maximum of the transmitted intensity is in the ratio $1 : q$. The ratio of intensities of polarised to unpolarised light in the incident beam is

- (A) $\frac{1}{2}(q - 1) : 1$ (B) $1 : \frac{1}{2}(q - 1)$ (C) $\frac{1}{2}q : 1$ (D) $1 : \frac{1}{2}q$

5.9 A cubical box of side 0.20 m is constructed from 0.012 m thick concrete panels of thermal conductivity $K=0.8\text{ W m}^{-1}\text{ K}^{-1}$. A 100 W heater is sealed inside the box and switched on. The temperature of air outside the box is 20°C . After a long period of time, the air temperature inside the box will be close to

- (A) 20°C (B) 22°C (C) 24°C (D) 26°C

5.10 An experiment requires a gas with $\gamma = 1.50$. This can be achieved by mixing together monatomic and rigid diatomic ideal gases. The ratio of moles of the monatomic to diatomic gas in the mixture is

- (A) 1:3 (B) 2:3 (C) 1:1 (D) 3:4

For questions 5.11 to 5.15, **one or more than one** of the 4 options may be correct. Your answer is regarded correct **only if you choose all the correct option(s) and no incorrect option(s)**. A correct answer will earn 4 marks, a wrong answer or an unattempted question will earn 0 marks.

5.11 A 3.0 m long metal pipe, closed at the top end, is held vertically above a large water tank. It is then very slowly pushed vertically down into the water and held there such that the top end of the pipe is at level with the water surface. Take the density of water to be 1000 kgm^{-3} . Then

- (A) the length of the trapped air column is 2.8 m.
- (B) the pressure of the trapped air is 1.24 times the atmospheric pressure.
- (C) the entropy of the air in the pipe decreases in this process.
- (D) the pipe executes simple harmonic oscillation when the top end of the pipe is released.

5.12 A ring of radius R is uniformly charged with linear charge density λ . A unit test charge of opposite sign is released from rest at a height $h > 2R$ from the centre of the ring. The test charge moves along the axis. Ignore the effect of gravity. Then

- (A) the test charge will execute simple harmonic motion about the centre of the ring.
- (B) the magnitude of the force on the test charge when it moves towards the centre of the ring, increases and then decreases.
- (C) the magnitude of the force on the test charge kept on the axis and near the centre of the ring decreases with increasing radius of the ring.
- (D) the speed of the test charge at the centre of the ring is proportional to λ .

5.13 A horizontal bar has mass 5 kg, length 0.30 m and has a mass M at one end as shown in the accompanying schematic sketch. A cable is attached at point A , 0.05 m from the pivot point (fulcrum) P and its other end makes a negligible angle with the a rod joined to the pivot P . The top end of the rod is fixed to the roof. The maximum tension the cable can withstand is 1050 N. Then

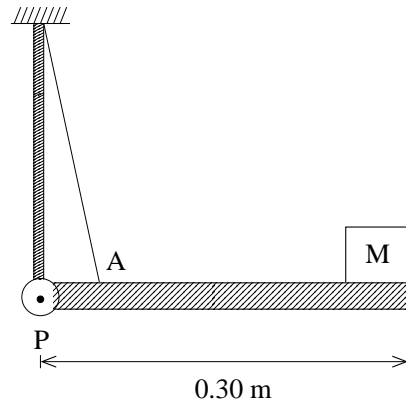

- (A) the maximum value of M is 15 kg.
- (B) this design has the maximum mechanical advantage.
- (C) the maximum value of the horizontal component of the force at the pivot is 1050 N.
- (D) the maximum value of the normal component of the force at the pivot is 850 N.

5.14 The switch S , shown in the circuit below (i.e. figure (a)), closes when $V_c > 2V/3$ and opens when $V_c < V/3$. The variation of V_c with time is shown in the graph below (i.e. figure (b)).

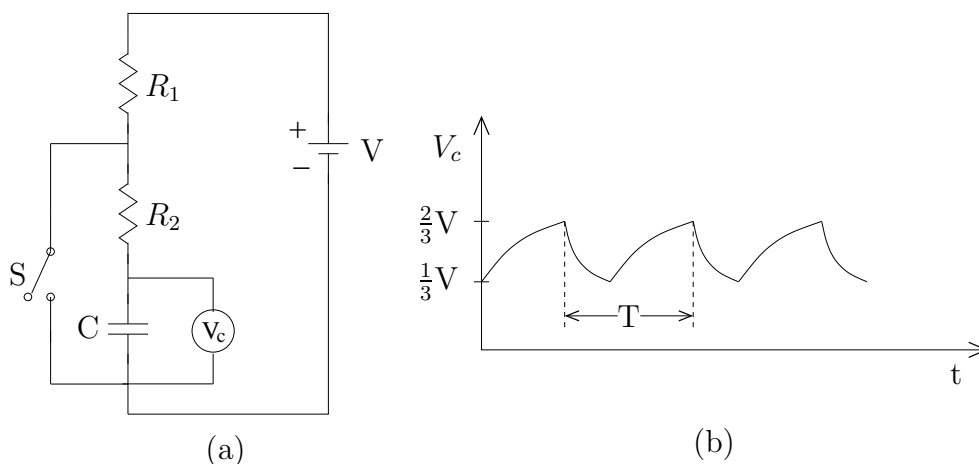

Then,

- (A) the time required for C to discharge is $(2R_1 + R_2)C \ln 2$.
- (B) the period T of the waveform is $(R_1 + 2R_2)C \ln 2$.
- (C) the rise and decay times of V_c are equal.
- (D) the time required for V_c to rise to maximum value is $(R_1 + R_2)C \ln 2$.

5.15 Consider the following decay schemes:

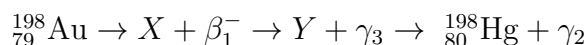
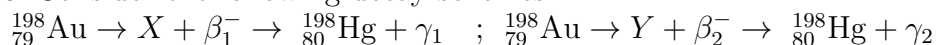

The energies corresponding to X and Y with respect to ${}^{198}_{80}\text{Hg}$ are 1.088 MeV and 0.412 MeV respectively [Note the energy of ${}^{198}_{80}\text{Hg}$ is taken to be 0.0 MeV]. The atomic masses of ${}^{198}_{79}\text{Au}$ and ${}^{198}_{80}\text{Hg}$ are 197.968 u and 197.966 u, respectively, where 1 u should be taken as 931 MeV/ c^2 . Then,

- (A) the energies corresponding to γ_1 and γ_2 are 1.088 MeV and 0.412 MeV respectively.
- (B) the energies corresponding to γ_1 and γ_3 are 1.088 MeV and 0.412 MeV respectively.
- (C) the maximum kinetic energies of β_1^- and β_2^- are about 0.77 MeV and 1.45 MeV respectively.
- (D) the energy corresponding to ${}^{198}_{79}\text{Au}$ is 1.50 MeV.

SPACE FOR ROUGH WORK